

NX

INDEX

160	AALTO
218	ADAK
140	ARAN
106	ARNIM
206	BAXE
210	BELO
172	BLEV
156	BOXY
212	COLTON
112	DOLOM
184	DOKI 2.0
188	DOKI
218	DOKI MINI
217	EFFI
168	ELEM
164	ELYSÉE
174	FEMTY
136	GRID
98	HAYEM
202	HOBRO
190	HYGGE
148	KIBELL
116	KLINT
40	LINJER
176	MALMÖ
102	MARMOR
122	MEMPHIS
216	NEBBE
198	PEPA
68	PRENN
180	PUMA
50	ROTEN
20	SHOSUBA
132	TULIP
4	UNDA
86	VALNÖT
214	COMPLEMENTOS / COMPLEMENTS
220	MEDIDAS MUEBLES / MESURES MEUBLES / VANITY MEASUREMENTS
228	MEDIDAS ESPEJOS / MESURES MIROIRS / MIRROR MEASUREMENTS
231	LAVABOS / PLAN VASQUES / WASHBASINS
236	ILUMINACIÓN / ÉCLAIRAGE / LIGHTING
237	ACABADOS / FINITIONS / FINISHES



UNDA

Unda - 1Q84 - llargi





Unda - 1Q84 - llargi





UNDA

Unda - Forma Large - Aalto



10 | 11



Unda - Forma Large - Aalto





UNDA

Unda - Daro - Aalto





Unda - Daro - Aalto



UNDA

Unda - Rodó - Capiton



Unda - Rodó - Capiton





SHOSUBA

Shosuba - Prim - Capiton





Shosuba - Prim - Capiton





SHOSUBA

Shosuba - Rodó - Eris



Shosuba - Rodó - Eris



SHOSUBA

Shosuba - Oval - Dondo XXL





Shosuba - Oval - Dondo XXL





SHOSUBA

Shosuba - 1Q84 - Magnetic





Shosuba - 1Q84 - Magnetic



SHOSUBA

Shosuba - Prim - Dondo XXL





Shosuba - Prim - Dondo XXL





LINJER

Linjer - Oval - llargi





Linjer - Oval - llargi





Linjer - 2R - llargi





LINJER

Linjer - Daro - Eris





Linjer - Daro - Eris

48 | 49





50 | 51

ROTEN

Roten - Forma Large - llargi - Ren







Roten - Forma Large - llargi - Ren



ROTEN

Roten - 1Q84 - Eris - Ren 50





Roten - 1Q84 - Eris - Ren 50





60 | 61



Roten - 1Q84 - Eris - Ren 50





ROTEN

Roten - Forma Large - Aalto





Roten - Forma Large - Aalto



Roten - Forma Large - Aalto





68 | 69



PRENN

Prenn - 1Q84





PRENN

Prenn - Daro

72173



PRENN

Prenn - Prim





Prenn - Prim



76 | 77

PRENN

Prenn - Oval - Capiton





PRENN

Prenn - Elara



84185



PRENN



VALNÖT

Valnöt - Oval - Aalto





Valnöt - Oval - Aalto



VALNÖT

Valnöt - Patra - llargi







VALNÖT

Valnöt - Kolo - Dondo XXL - Ren 80



VALNÖT
Valnöt - Mimas - Elara



98 | 99

HAYEM

Hayem - Ofali - Aalto - Cubo



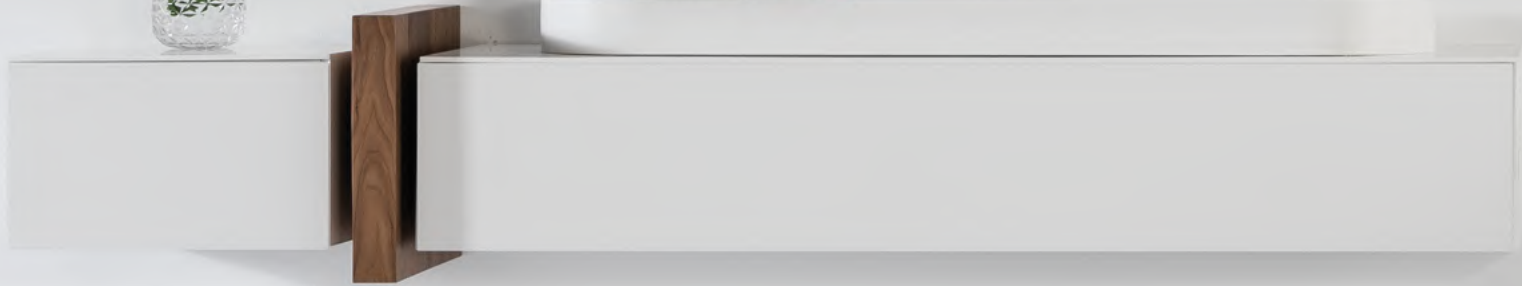
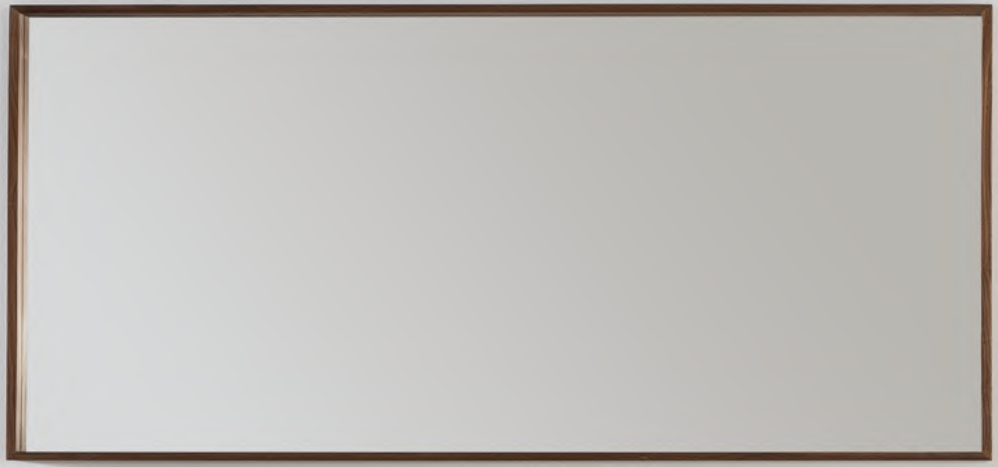



MARMOR

Marmor - Magnetic



MARMOR

Marmor - Callisto - Ren 50



ARNIM

Arnim - 1Q84 - llargi - Ren



Arnim - 1Q84





ARNIM

Arnim - 1Q84 - Haruki



DOLOM

Dolom - llargj



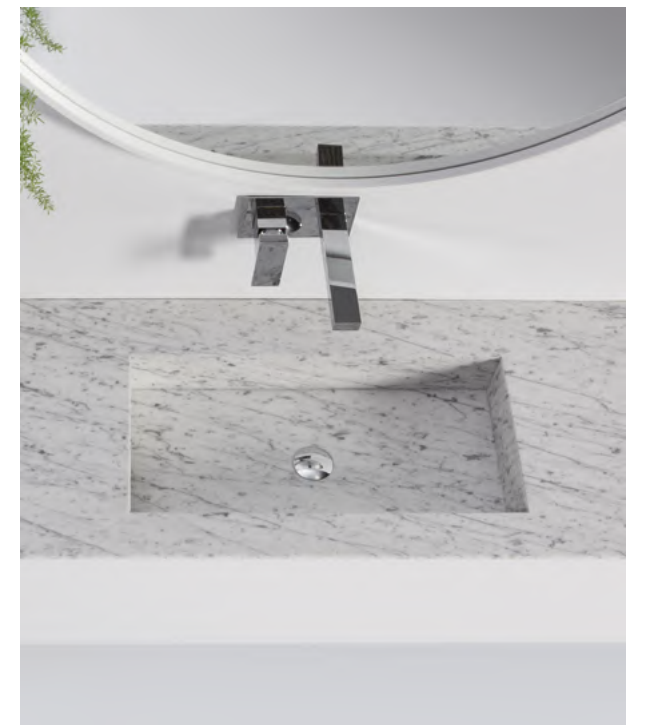

DOLOM

Dolom - llargi - Ren 80



KLINT

Klint - 1Q84 - Eris



Klint - 1Q84 - Eris





KLINT

Klint - Forma Small - Ilgora



MEMPHIS

Memphis 80 - Lao - Ilgora





MEMPHIS

Memphis 80 - Lao - Ilgora - Cubo



MEMPHIS



MEMPHIS

Memphis 130 - Lao - Haruki - Ren 80



TULIP

Tulip - Tulpan - Dondo XXL - Ren Small





TULIP

Tulip - Latu - Ilargi - Ren Small



GRID

Grid - Mimas - Elara - Ren



GRID

Mimas - Kolo



140 | 141

ARAN

Aran - Forma Large - Magnetic - Ren 80 - Nebbe





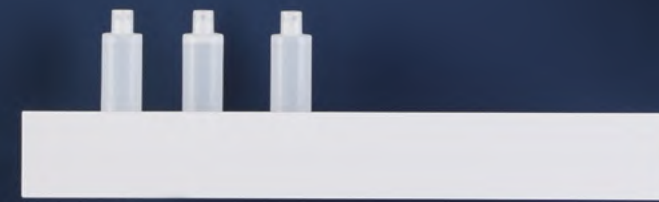



ARAN

Aran - Forma Small - Dondo - Ren



148 | 149

KIBELL

Kibell - Lorca - Dondo







Kibell - Lorca - Dondo





Kibell - Kolo - Isi





BOXY

Boxy - Mimas - Elara



BOXY

Boxy - Mimas - Elara





160 | 161

AALTO

Aalto - Prenn - Elara





Aalto - Prens



ELYSÉE

Elysée - Elara







168 | 169

ELEM

Elem - Alma - Dondo XXL - Cubo





ELEM

Elem - Alpos - Elara - Cubo



172 | 173

BLEV

Blev - Kolo



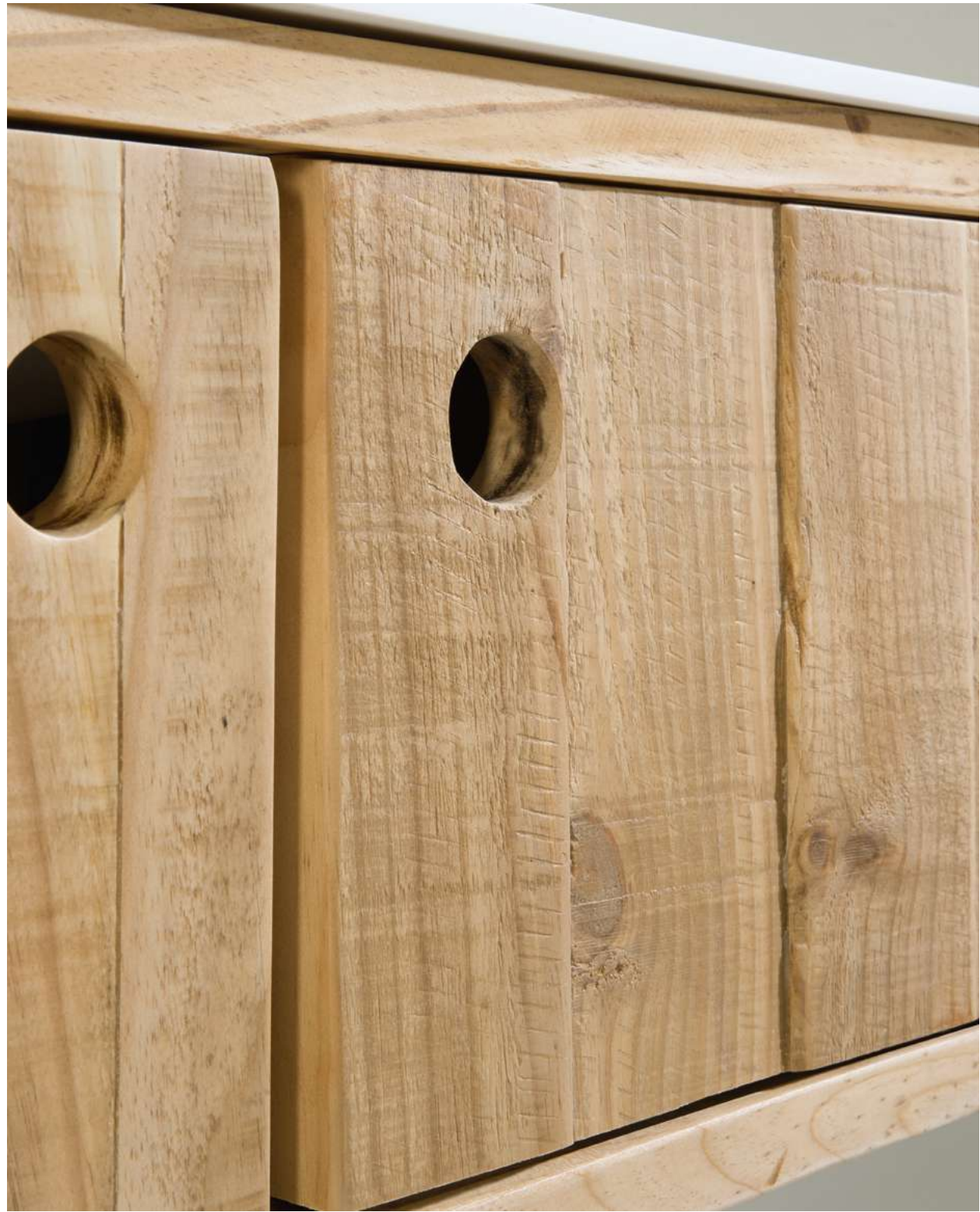

FEMTY

Fenty - Kolo - Isi





176 | 177



MALMÖ

Malmö



MALMÖ

Malmö





PUMA

Puma





PUMA

Puma - Nit - Dondo



DOKI 2.0

Doki 2.0 - Dana Small - Doxu - Ren



Doki 2.0 - Lao - Doxu - Ren 50 - Ren Small



Doki 2.0 - Cambrils - Doxu



DOKI

Doki - Cambrils - Doxu



HYGGE

Hygge - Milo





HYGGE

Hygge - Dondo



192 | 193

HYGGE

Hygge - Elara



HYGGE

Hygge - Elara - Ren

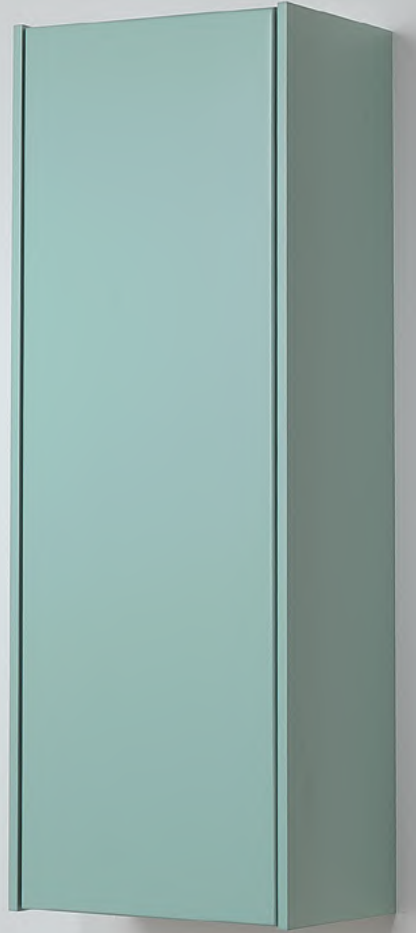



198 | 199

PEPA

Pepa - Doru - Callisto - Ren





PEPA

Pepa - Doru - Milo - Doki



HOBRO

Hobro - Cambrils - Milo - Cubo - Ren - Doki



Hobro - Forma Small - Milo



HOBRO

Hobro - Forma Large - Doxu





BAXE

Baxe - Darito - Isi - Ren





BAXE

Baxe - Lao - Isi





BELO

Belo - Doru - Milo - Pepa





COLTON

Colton - Forma Small - Ilgora - Ren



COMPLEMENTS

Cubo - Ren 80 - Doki Mod.



COMPLEMENTS



Doki sem.



Nebbe



Doki mod.



Effi

COMPLEMENTS



Kibell



Doki mini



Adak



Ren 35 - Ren Small



Ren 50 - Ren 80

MUEBLES / MEUBLES / VANITIES

AALTO [mueble / meuble / vanity]

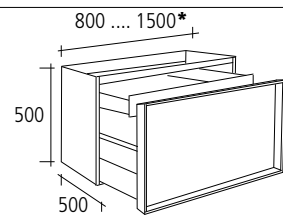

(ES) Madera (FR) Bois (EN) Wood

- 052 (ES) Nogal Americano (FR) Noyer Américain (EN) American Walnut
- 061
- 051 (ES) Roble Americano (FR) Chêne Américain (EN) American Oak
- 062

*(ES) Ancho a medida (FR) Largeur sur mesure (EN) Tailored Length

ADAK [mueble / meuble / vanity]

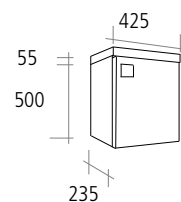

(ES) Brillo (FR) Brillant (EN) Gloss

- 025
- (ES) Satinado (FR) Satiné (EN) Silk
- 015 117 111 014 013 115 116
- 114 012 027 016 017 019 113

(ES) Melaminado (FR) Mèlaminé (EN) Melamine

- 041 043 042 044 045

ARAN [mueble / meuble / vanity]

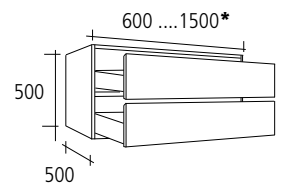

(ES) Brillo (FR) Brillant (EN) Gloss

- 025
- (ES) Satinado (FR) Satiné (EN) Silk
- 015 117 111 014 115 116 114 017 113 019

(ES) Texturado (FR) Texturé (EN) Textured

- 081 082 083 084

*(ES) Ancho a medida (FR) Largeur sur mesure (EN) Tailored Length

ARNIM [mueble / meuble / vanity]

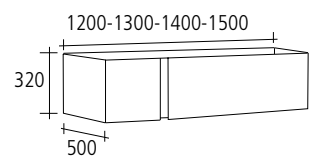

(ES) Brillo (FR) Brillant (EN) Gloss

- 025

(ES) Satinado (FR) Satiné (EN) Silk

- 011

(ES) Mármol (FR) Marbre (EN) Marble

- 071 072 073 074

BELO [mueble / meuble / vanity]

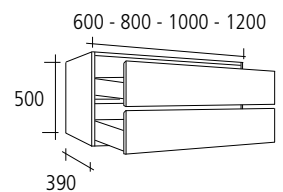

(ES) Brillo (FR) Brillant (EN) Gloss

- 025

(ES) Satinado (FR) Satiné (EN) Silk

- 015 117 111 014 115 013

- 116 114 017 019 113

(ES) Melaminado (FR) Mèlaminé (EN) Melamine

- 041 043 042 044 045

BLEV [mueble / meuble / vanity]

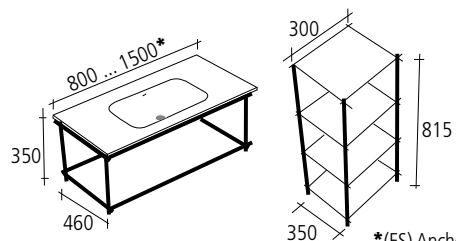

(ES) Madera (FR) Bois (EN) Wood

- 051 (ES) Roble Americano (FR) Chêne Américain (EN) American Oak

- 052 (ES) Nogal Americano (FR) Noyer Américain (EN) American Walnut

*(ES) Ancho a medida (FR) Largeur sur mesure (EN) Tailored Length

BOXY [mueble / meuble / vanity]

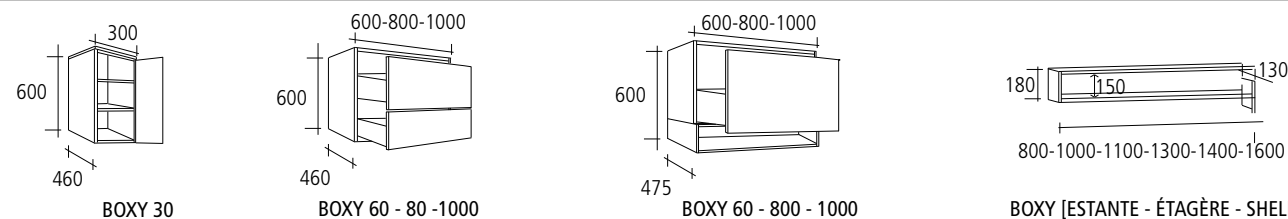

(ES) Satinado (FR) Satiné (EN) Silk

- 011 015 117 014 115 027 016

(ES) Texturado (FR) Texturé (EN) Textured

- 081 082 083 084

BOXY [ESTANTE - ÉTAGÈRE - SHELF]

COLTON [mueble / meuble / vanity]

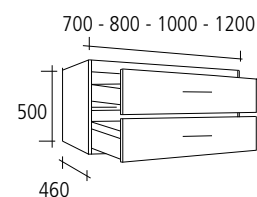

(ES) Brillo (FR) Brillant (EN) Gloss

- 025

(ES) Satinado (FR) Satiné (EN) Silk

- 015 117 111 014 013 115 116

- 114 012 027 017 019 113

(ES) Melaminado (FR) Mèlaminé (EN) Melamine

- 041 043 042 044 045

DOKI MINI [mueble / meuble / vanity]

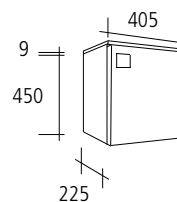

(ES) Brillo (FR) Brillant (EN) Gloss

- 025

(ES) Satinado (FR) Satiné (EN) Silk

- 015 117 111 014 013 115 116

- 114 012 027 016 017 019 113

(ES) Melaminado (FR) Mèlaminé (EN) Melamine

- 041 043 042 044 045

DOLOM [mueble / meuble / vanity]

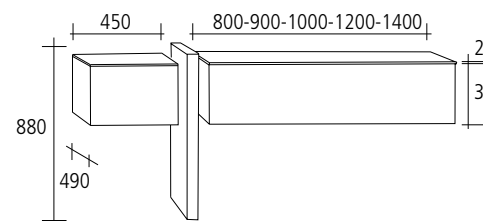

(ES) Brillo (FR) Brillant (EN) Gloss (ES) Satinado (FR) Satiné (EN) Silk

- 025 111

(ES) Mármol natural (FR) Marbre (EN) Marble

- 071 072 073 074

ELEM [mueble / meuble / vanity]

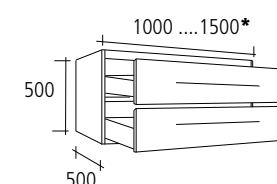

(ES) Satinado (FR) Satiné (EN) Silk

- 027 011 015 117 115 016 017

(ES) Texturado (FR) Texturé (EN) Textured

- 081 082 083 084

(ES) Madera (FR) Bois (EN) Wood

- 052 (ES) Nogal Americano (FR) Noyer Américain (EN) American Walnut
- 051 (ES) Roble Americano (FR) Chêne Américain (EN) American Oak

*(ES) Ancho a medida (FR) Largeur sur mesure (EN) Tailored Length

ELYSÉE [mueble / meuble / vanity]

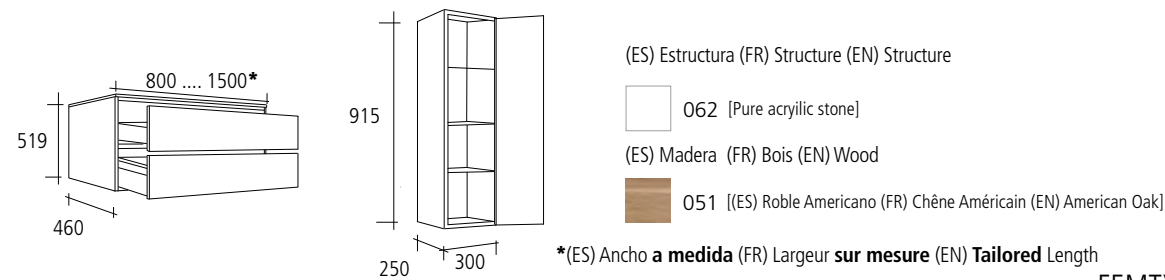

(ES) Estructura (FR) Structure (EN) Structure

062 [Pure acrylic stone]

(ES) Madera (FR) Bois (EN) Wood

051 [(ES) Roble Americano (FR) Chêne Américain (EN) American Oak]

* (ES) Ancho a medida (FR) Largeur sur mesure (EN) Tailored Length

FEMTY [mueble / meuble / vanity]

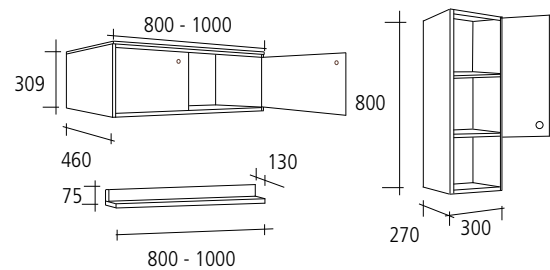

(ES) Madera (FR) Bois (EN) Wood

054 [(ES) Madera envejecida (FR) Bois Vieilli (EN) Distressed wood)]

GRID [mueble / meuble / vanity]

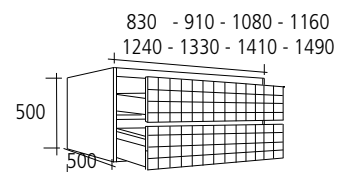

(ES) Madera (FR) Bois (EN) Wood

051 [(ES) Roble Americano (FR) Chêne Américain (EN) American Oak)]

HAYEM [mueble / meuble / vanity]

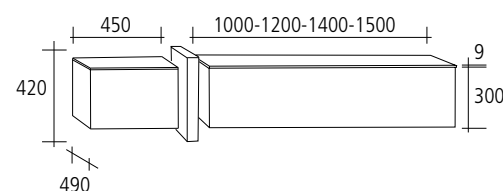

(ES) Brillo (FR) Brillant (EN) Gloss

025

(ES) Satinado (FR) Satiné (EN) Silk

011

(ES) Madera (FR) Bois (EN) Wood

052 [(ES) Nogal Americano (FR) Noyer Américain (EN) American Walnut)]

HYGGE [mueble / meuble / vanity]

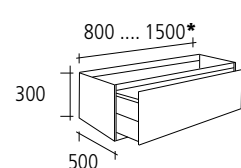

A (ES) Mueble lacado (FR) Meuble laqué (EN) Lacquered Vanity

012 011 111 117 015 114 019

115 016 017

081 082 083 084

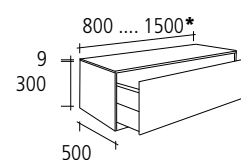

B (ES) Frente Rechapado (FR) Façade plaquée bois (EN) Veneered front

011 015 019 016 017 + 061 062

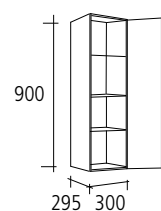

C (ES) Mármol (FR) Marbre (EN) Marble

071 + 011

* (ES) Ancho a medida (FR) Largeur sur mesure (EN) Tailored Length

KIBELL [mueble / meuble / vanity]

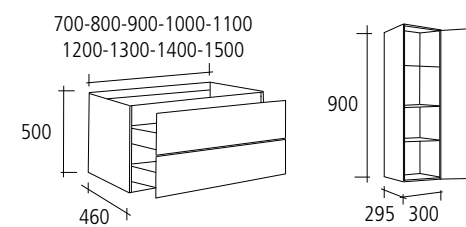

(ES) Brillo (FR) Brillant (EN) Gloss

025

(ES) Satinado (FR) Satiné (EN) Silk

015 117 111 014 013 115 116

114 012 027 016 017 019 113

(ES) Texturado (FR) Texturé (EN) Textured

081 082 083 084

LINJER [mueble / meuble / vanity]

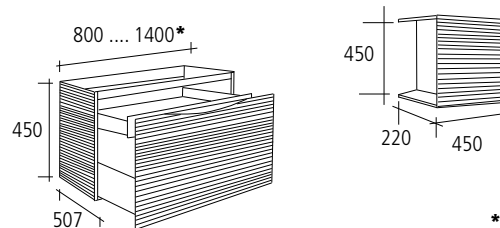

(ES) Madera (FR) Bois (EN) Wood

056 [(ES) Fresno (FR) Frêne (EN) Ash)]

* (ES) Ancho a medida (FR) Largeur sur mesure (EN) Tailored Length

MALMÖ [mueble / meuble / vanity]

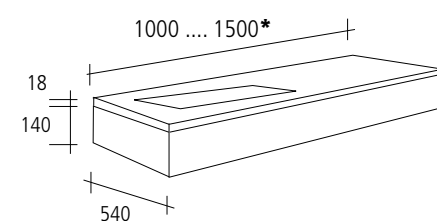

SOPORTE con Lavabo / SUPPORT avec Plan Vasque
SUPPORT with Washbasin

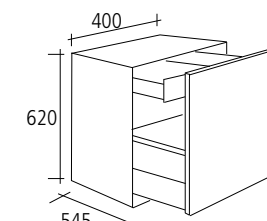

MALMÖ 40
PUSH - PULL
[Madera / Wood / Bois]

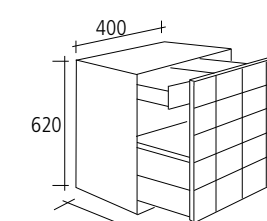

MALMÖ 40
PUSH

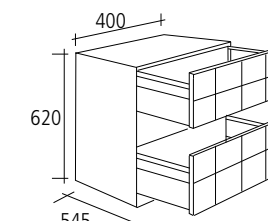

MALMÖ 40
PULL

222 | 223

(ES) Satinado (FR) Satiné (EN) Silk

012 011 015 014 016 017

(ES) Texturado (FR) Texturé (EN) Textured

081 082 083 084

(ES) Madera (FR) Bois (EN) Wood

051 [(ES) Roble Americano (FR) Chêne Américain (EN) American Oak)]

* (ES) Ancho a medida (FR) Largeur sur mesure (EN) Tailored Length

MARMOR [mueble / meuble / vanity]

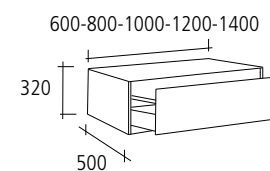

(ES) Brillo (FR) Brillant (EN) Gloss

025

(ES) Satinado (FR) Satiné (EN) Silk

011

MEMPHIS [mueble / meuble / vanity]

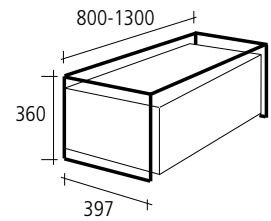

MEMPHIS [ES] con cajonera [FR] avec tiroir [EN] with drawer

- (ES) Satinado (FR) Satiné (EN) Silk
 011 027 017 015 116
 114 117 111 115 019
 (ES) Texturado (FR) Texturé (EN) Textured
 081 082 083 084

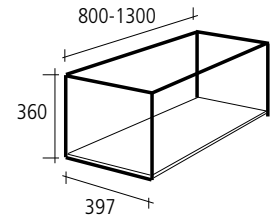

MEMPHIS [es] con estante madera maciza [fr] avec étagère en bois massif [en] with solid wooden shelf

- (ES) Madera (FR) Bois (EN) Wood
 052 [(ES) Nogal Americano (FR) Noyer Américain (EN) American Walnut]

PEPA [mueble / meuble / vanity]

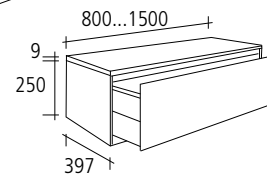
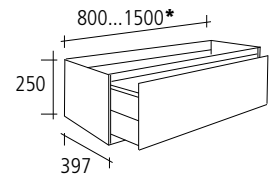

- (ES) Brillo (FR) Brillant (EN) Gloss
 025
 (ES) Satinado (FR) Satiné (EN) Silk
 015 117 111 014 115 013
 116 114 017 019 113
 (ES) Texturado (FR) Texturé (EN) Textured
 081 082 083 084

*(ES) Ancho a medida (FR) Largeur sur mesure (EN) Tailored Length PRENN [mueble / meuble / vanity]

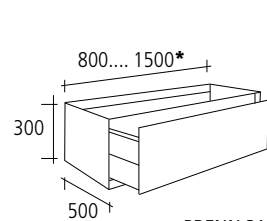

PRENN 31

(ES) Madera (FR) Bois (EN) Wood

- 051 [(es) Roble Americano (fr) Chêne Américain (eng) American Oak]
 053 [Iroko]

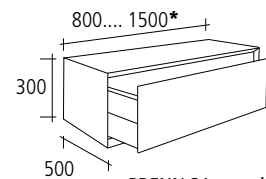

PRENN 31 compl.

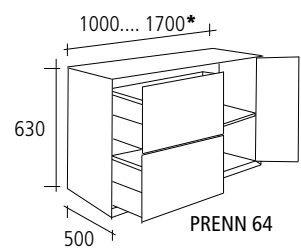

PRENN 64

- 052 [(ES) Nogal Americano (FR) Noyer Américain (EN) American Walnut]
 057 [(ES) Fresno quemado (FR) Frêne brûlé (EN) Burned Ash]

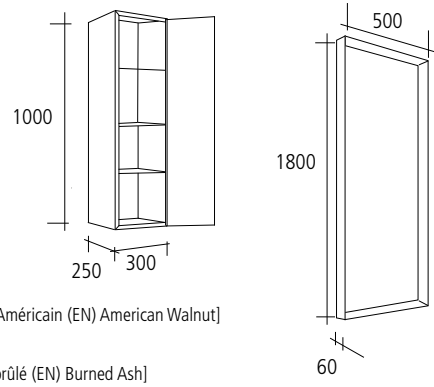

*(ES) Ancho a medida (FR) Largeur sur mesure (EN) Tailored Length

PUMA [mueble / meuble / vanity]

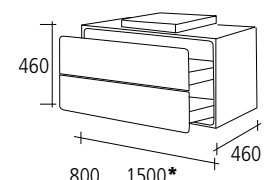

PUMA 90

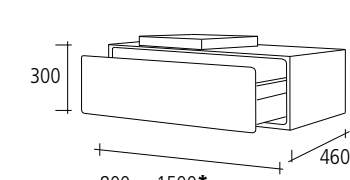

PUMA 100

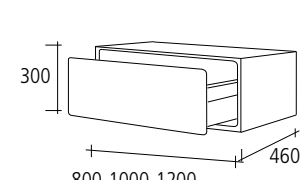

PUMA COMPL.

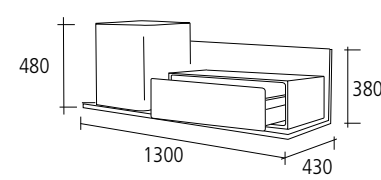

PUMA 130

- (ES) Frente (FR) Façade (EN) Fronts
 062 [Pure acrylic stone]
 (ES) Madera (FR) Bois (EN) Wood
 051 [(ES) Roble Americano (FR) Chêne Américain (EN) American Oak]

*(ES) Ancho a medida (FR) Largeur sur mesure (EN) Tailored Length

ROTEN [mueble / meuble / vanity]

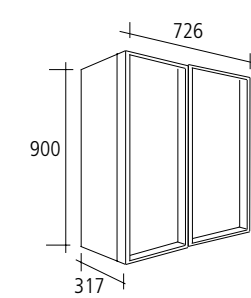
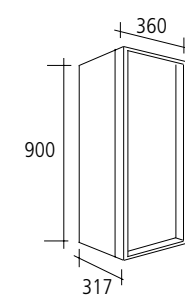
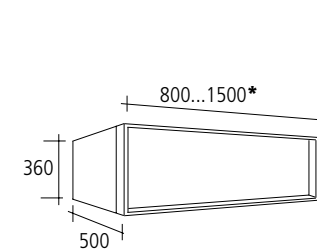

- (ES) Satinado (FR) Satiné (EN) Silk
 011 019
 (ES) Madera (FR) Bois (EN) Wood
 056 [(ES) Fresno (FR) Frêne (EN) Ash]

*(ES) Ancho a medida (FR) Largeur sur mesure (EN) Tailored Length

SHOSUBA [mueble / meuble / vanity]

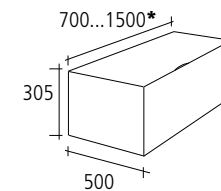

SOSHUBA

[ES] cajonera [FR] tiroir [EN] drawer

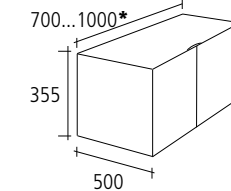

SOSHUBA

[ES] 2 puertas [FR] 2 portes [EN] 2 doors

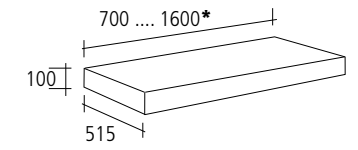

SHOSUBA

[ES] encimera [FR] plan travail [EN] worktop

- (ES) Satinado (FR) Satiné (EN) Silk
 011 027 017 015 116
 114 117 111 115 019
 (ES) Texturado (FR) Texturé (EN) Textured
 081 082 083 084

- (ES) Madera (FR) Bois (EN) Wood
 056 [(ES) Fresno (FR) Frêne (EN) Ash]
 057 [(ES) Fresno quemado (FR) Frêne brûlé (EN) Burned Ash]

*(ES) Ancho a medida (FR) Largeur sur mesure (EN) Tailored Length

TULIP [mueble / meuble / vanity]

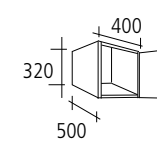

TULIP

*(ES) Ancho a medida (FR) Largeur sur mesure (EN) Tailored Length

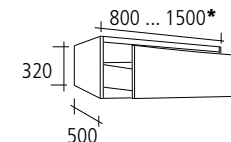

TULIP COMPL.

TULIP COMPL.

TULIP COMPL.

TULIP COMPL.

- (ES) Madera (FR) Bois (EN) Wood
 055 [tulipier]

UNDA [mueble / meuble / vanity]

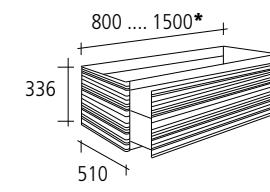

- (ES) Madera (FR) Bois (EN) Wood
 052 [(ES) Nogal Americano (FR) Noyer Américain (EN) American Walnut]
 056 [(ES) Fresno (FR) Frêne (EN) Ash]

*(ES) Ancho a medida (FR) Largeur sur mesure (EN) Tailored Length

VALNÖT [mueble / meuble / vanity]

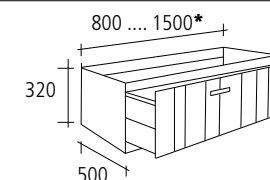

- (ES) Madera (FR) Bois (EN) Wood
 052 [(es) Nogal Americano (fr) Noyer Américain (eng) American Walnut]

*(ES) Ancho a medida (FR) Largeur sur mesure (EN) Tailored Length

COMPLEMENTOS / COMPLEMENTS

KIBELL [accesorios / accessories / accessoires]

CUADRO [accesorios / accessories / accessoires]

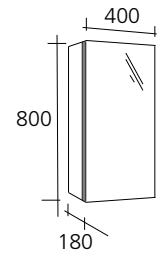

- (ES) Brillo (FR) Brillant (EN) Gloss
 025
- (ES) Satinado (FR) Satiné (EN) Silk
 015 117 111 014 013 115 116
 114 012 027 016 017 019 113
- (ES) Melaminado (FR) Mèlaminé (EN) Melamine
 041 043 042 044 045

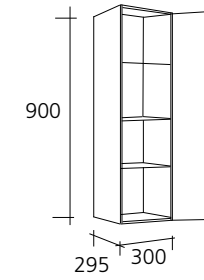

- (ES) Brillo (FR) Brillant (EN) Gloss
 025
- (ES) Satinado (FR) Satiné (EN) Silk
 015 117 111 014 013 115 116
 114 012 027 011 016 017 019 113
- (ES) Texturado (FR) Texturé (EN) Textured
 081 082 083 084

NEBBE [accesorios / accessories / accessoires]

CUBO [accesorios / accessories / accessoires]

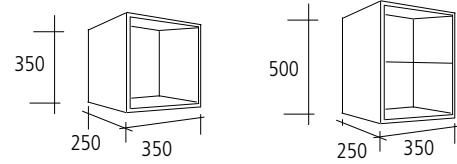

CUBO 35

CUBO 50

- (ES) Madera (FR) Bois (EN) Wood
 051 [(ES) Roble Americano (FR) Chêne Américain (EN) American Oak]
 052 [(ES) Nogal Americano (FR) Noyer Américain (EN) American Walnut]

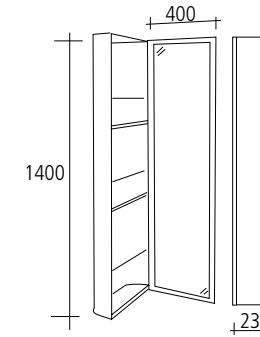

- (ES) Brillo (FR) Brillant (EN) Gloss
 025
- (ES) Satinado (FR) Satiné (EN) Silk
 015 117 111 014 013 115 116
 114 012 027 011 016 017 019 113

DOKI [accesorios / accessories / accessoires]

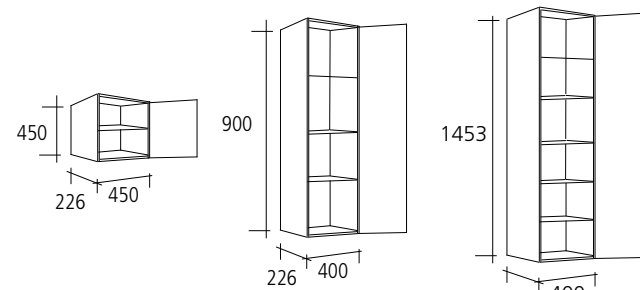

DOKI MOD.

DOKI SEM.

DOKI COL.

- (ES) Brillo (FR) Brillant (EN) Gloss
 025
- (ES) Satinado (FR) Satiné (EN) Silk
 015 117 111 014 013 115 116
 114 012 027 011 016 017 019 113
- (ES) Melaminado (FR) Mèlaminé (EN) Melamine
 041 043 042 044 045

EFFI [accesorios / accessories / accessoires]

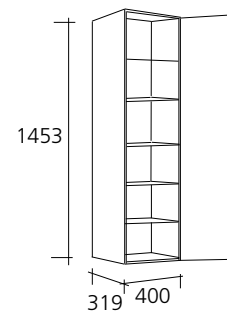

- (ES) Brillo (FR) Brillant (EN) Gloss
 025
- (ES) Satinado (FR) Satiné (EN) Silk
 015 117 111 014 013 115 116
 114 012 027 011 016 017 019 113
- (ES) Melaminado (FR) Mèlaminé (EN) Melamine
 041 043 042 044 045

226 | 227

REN [accesorios / accessories / accessoires]

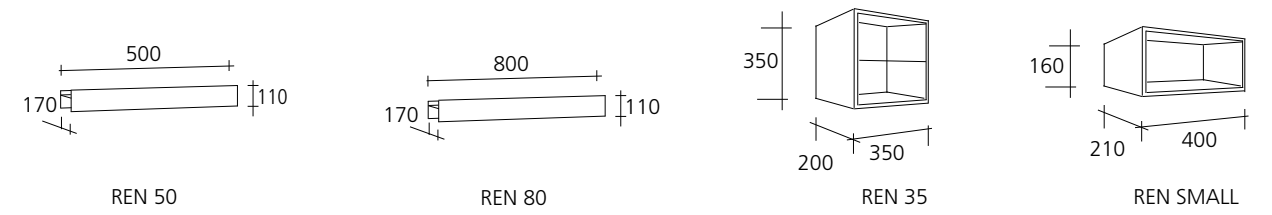

REN 50

REN 80

REN 35

REN SMALL

- 062 [pure acrylic stone]

[divisorias / séparateurs / dividers]

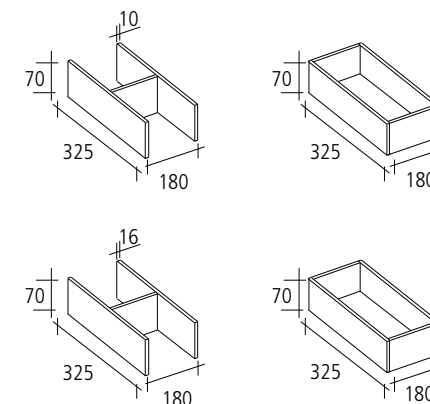

- (ES) Satinado (FR) Satiné (EN) Silk
 015 117 111 014 013 115 116
 114 012 027 011 016 017 019 113
- (ES) Contrachapado (FR) Contreplaqué (EN) Plywood
 [mansonia]

ESPEJOS / MIRRORS / MIROIRS

AALTO [espejo / mirror / miroir]

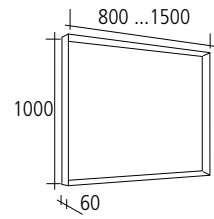

(ES) Madera (FR) Bois (EN) Wood

- 051 [(ES) Roble Americano (FR) Chêne Américain (EN) American Oak]
- 052 [(ES) Nogal Americano (FR) Noyer Américain (EN) American Walnut]
- 056 [(ES) Fresno (FR) Frêne (EN) Ash]

CALLISTO [espejo / mirror / miroir]

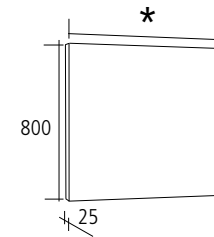

* 600-700-800-900-1000-1100-1200-1300-1400-1500

[ES] Espejo con retroiluminación LED y sistema de difusión de la luz / Sistema antivaho / Sensor para apagar/encender la luz.
 [EN] Mirror with Led backlight / Tactile switch system to switch on/off the lighting / No steam-system.
 [FR] Miroir avec rétroéclairage Led / Interrupteur tactile / Système antibuée.

CAPITON [espejo / mirror / miroir]

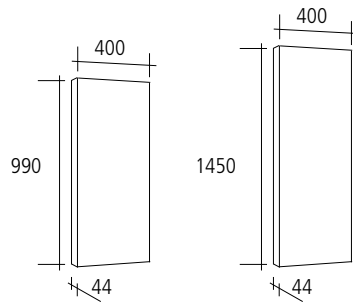

CAPITON 90* CAPITON 140

[ES] Sistema antivaho.
 [EN] No steam-system.
 [FR] Système antibuée.

CUADRO [espejo / mirror / miroir]

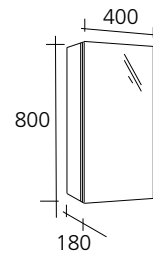

(ES) Brillo (FR) Brillant (EN) Gloss

- 025
- (ES) Satinado (FR) Satiné (EN) Silk
- 015 117 111 014 013 115 116
- 114 012 027 016 017 019 113
- (ES) Melaminado (FR) Mèlaminé (EN) Melamine
- 041 043 042 044 045

DONDO [espejo / mirror / miroir]

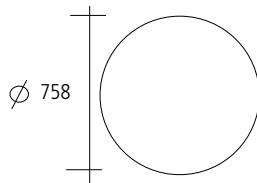

[ES] Sistema antivaho - Sensor para apagar/encender la luz.
 [EN] Tactile switch system to switch on/off the lighting - No steam-system.
 [FR] Interrupteur tactile - Système antibuée.

DONDO XXL [espejo / mirror / miroir]

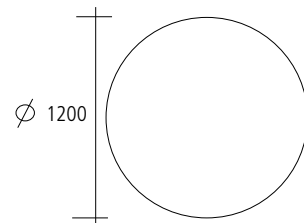

[ES] Sistema antivaho - Sensor para apagar/encender la luz.
 [EN] Tactile switch system to switch on/off the lighting - No steam-system.
 [FR] Interrupteur tactile - Système antibuée.

DOXU [espejo / mirror / miroir]

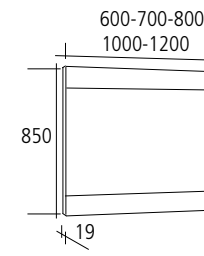

(ES) Brillo (FR) Brillant (EN) Gloss

- 025
- (ES) Satinado (FR) Satiné (EN) Silk
- 015 117 111 014 013 115 116
- 114 012 027 016 017 019 113
- (ES) Melaminado (FR) Mèlaminé (EN) Melamine
- 041 043 042 044 045

ELARA [espejo / mirror / miroir]

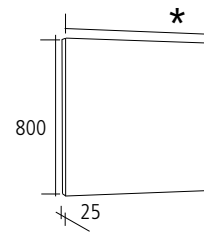

*600-700-800-900-1000-1100-1200-1300-1400-1500

[ES] Sistema antivaho - Sensor para apagar/encender la luz.
 [EN] Tactile switch system to switch on/off the lighting - No steam-system.
 [FR] Interrupteur tactile - Système antibuée.

ERIS [espejo / mirror / miroir]

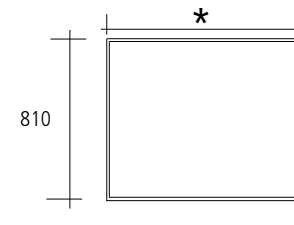

*600-700-800-900-1000-1100-1200-1300-1400-1500

062 [pure acrylic stone]

HARUKI [espejo / mirror / miroir]

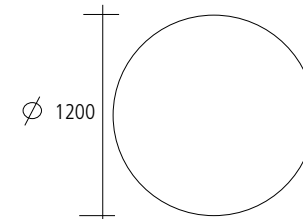

[ES] Espejo con etroiluminación LED y sistema de difusión de la luz - Sistema antivaho - Sensor para apagar/encender la luz.
 [EN] Mirror with Led backlight - Tactile switch system to switch on/off the lighting - No steam-system.
 [FR] Miroir avec rétroéclairage Led - Interrupteur tactile - Système antibuée.

228 | 229

ILARGI [espejo / mirror / miroir]

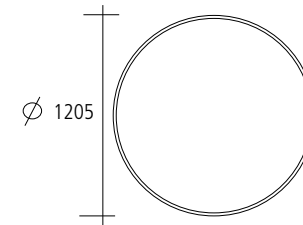

062 [pure acrylic stone]

ILGORA [espejo / mirror / miroir]

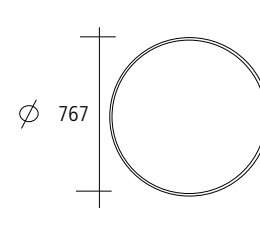

062 [pure acrylic stone]

ISI [espejo / mirror / miroir]

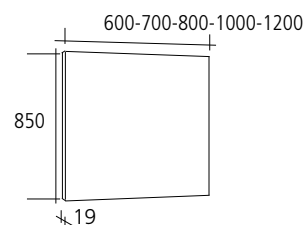

MALMÖ [espejo / mirror / miroir]

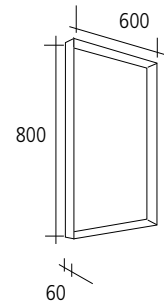

(ES) Satinado (FR) Satiné (EN) Silk



(ES) Metalizado (FR) Métallisé (EN) Metallic



(ES) Madera (FR) Bois (EN) Wood

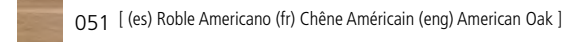

MAGNETIC [espejo / mirror / miroir]

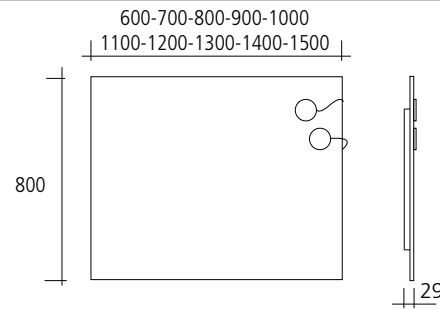

[ES] Espejo con 2 apliques magnéticos que se pueden mover libremente por la superficie del cristal.
 [EN] Mirror with 2 magnetic lights which can move freely on the surface of the mirror.
 [FR] Miroir avec 2 appliques aimantées qui peuvent se déplacer librement sur la surface du miroir.

MILO [espejo / mirror / miroir]

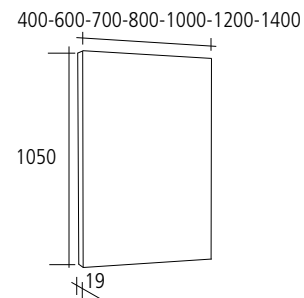

MINI [espejo / mirror / miroir]

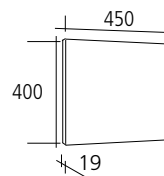

PUMA [espejo / mirror / miroir]

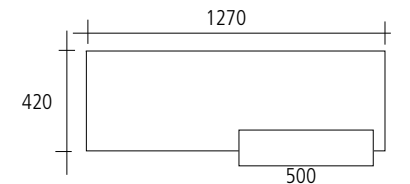

062 [pure acrylic stone]

PRENN [espejo / mirror / miroir]

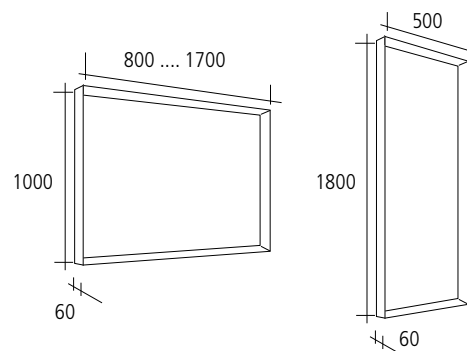

(ES) Madera (FR) Bois (EN) Wood

051 [(ES) Roble Americano (FR) Chêne Américain (EN) American Oak]

052 [(ES) Nogal Americano (FR) Noyer Américain (EN) American Walnut]

053 [Iroko]

057 [(ES) Fresno quemado (FR) Frêne brûlé (EN) Burned Ash)]

LAVABOS / PLAN VASQUES / WASHBASINS

FONDO 515 / PROFONDEUR 515 / 515 DEPTH

FONDO 460 / PROFONDEUR 460 / 460 DEPTH

ALMA

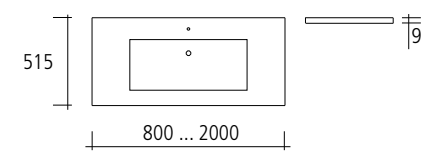

ELYSÉE

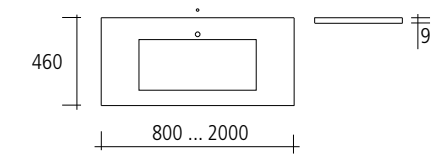

ALPOS

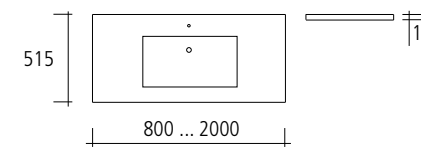

PALAS

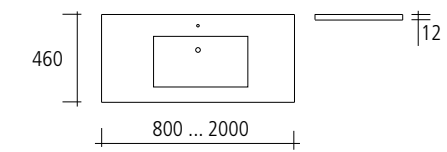

ARES

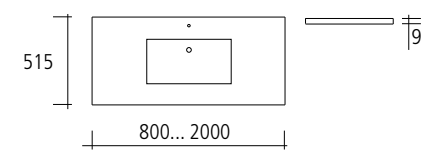

MIMAS

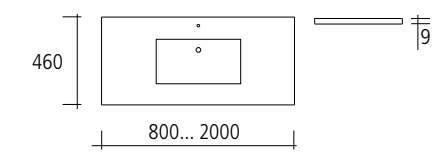

ARAN

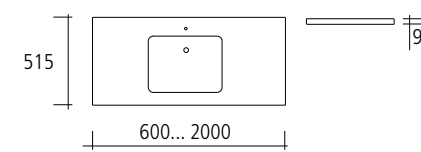

KOLO

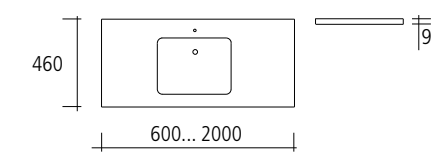

INIS

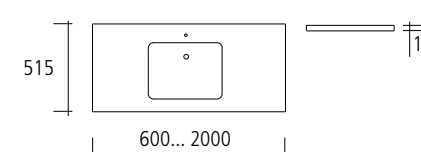

TALOS

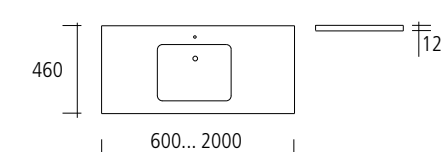

DARO

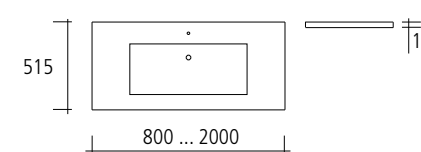

DARITO

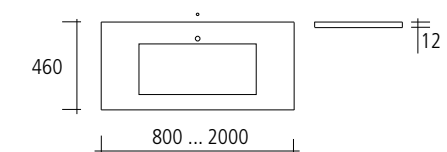

LATU

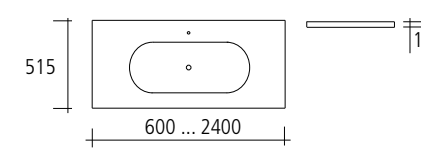

LAO

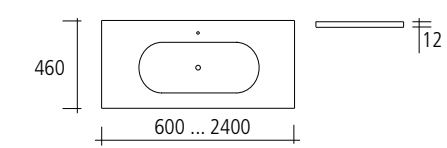

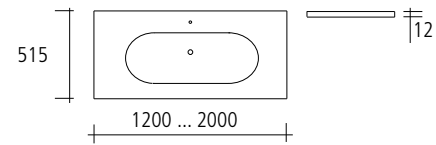
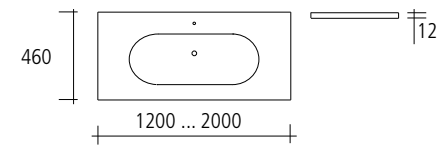
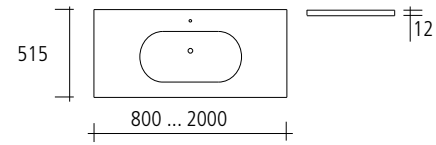
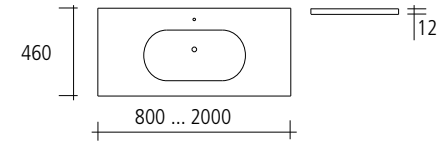
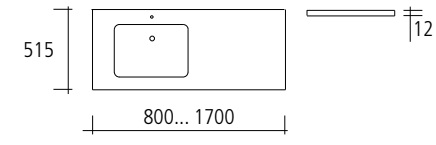
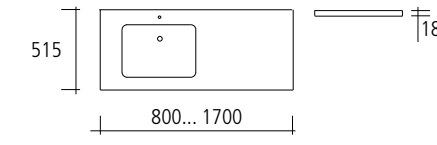
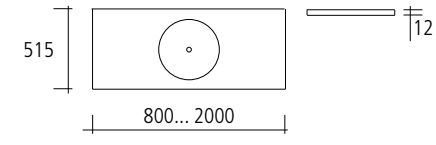
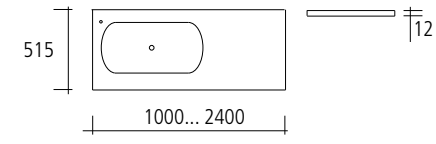
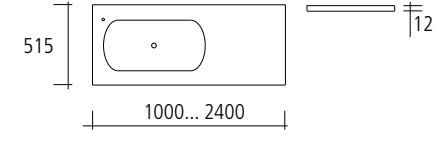
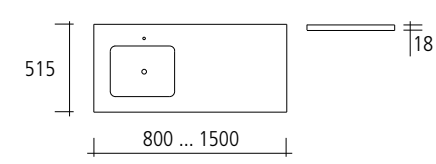
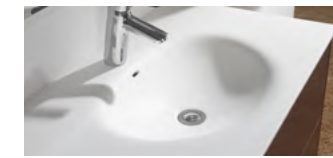
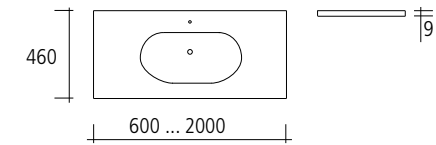
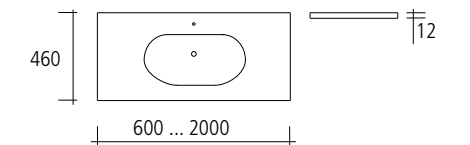
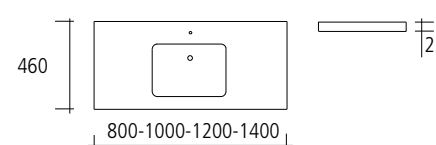
FONDO 515 / PROFONDEUR 515 / 515 DEPTH**FONDO 460 / PROFONDEUR 460 / 460 DEPTH****FORMA LARGE****DANA LARGE****FORMA SMALL****DANA SMALL****FONDO 515 / PROFONDEUR 515 / 515 DEPTH****BORVO****PRENN****2R****PATRA****TULPAN****HYGGE****FONDO 460 / PROFONDEUR 460 / 460 DEPTH****MAEN****STEN****LORCA***

* [ES]Material: Resina [FR] Matière: Résine [EN] Material: Resin

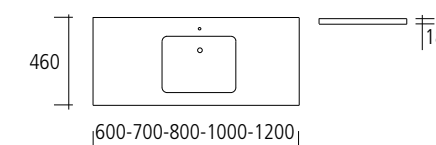
CAMBRILS*

* [ES]Material: Cerámica [FR] Matière: Céramique [EN] Material: Ceramic

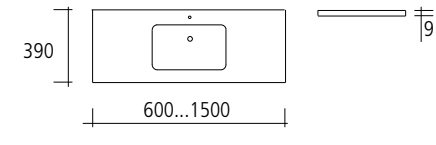
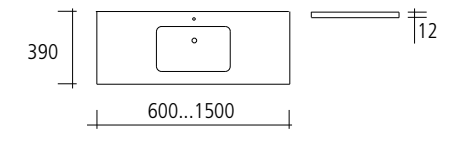
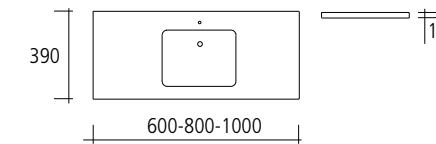
FONDO 390 / PROFONDEUR 390 / 390 DEPTH**DORU****LAPIS****BEKA**

* [ES]Material: Cerámica [FR] Matière: Céramique [EN] Material: Ceramic

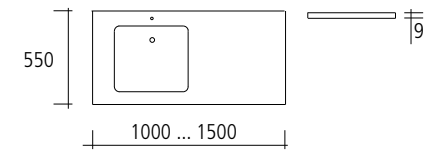
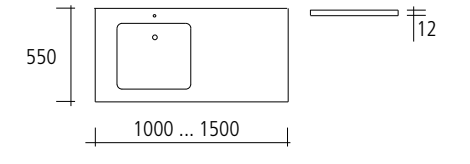
FONDO 550 / PROFONDEUR 550 / 550 DEPTH**CLERC****LUSK**

LAVABOS DE MÁRMOL NATURAL / PLAN VASQUE MARBRE NATUREL / NATURAL MARBLE WASHBASIN

DOLOM

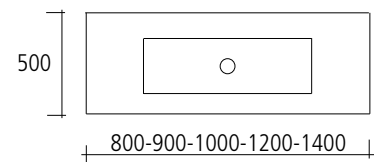

[ES] Compatible con la serie DOLOM.
[EN] Compatible with DOLOM collection.
[FR] Compatible avec la série DOLOM.



MARMOR

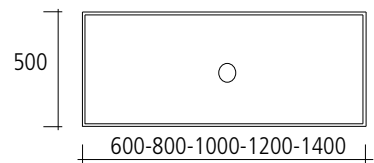

[ES] Compatible con la serie MARMOR.
[EN] Compatible with MARMOR collection.
[FR] Compatible avec la série MARMOR.



LAVABOS / VASQUES / BASINS

1Q84

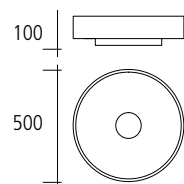

ADAK

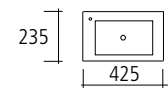

[ES] Compatible con la serie ADAK.
[EN] Compatible with ADAK collection.
[FR] Compatible avec la série ADAKI.

BIHAN

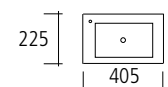

[ES] Compatible con la serie DOKI MINI.
[EN] Compatible with DOKI MINI collection.
[FR] Compatible avec la série DOKI MINI.

NIT

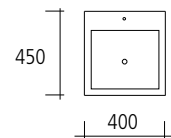

OFALI

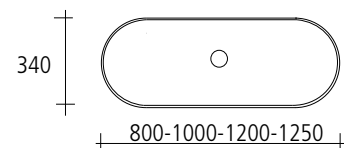

OVAL

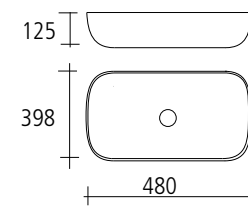

PUMA

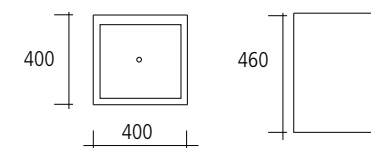

[ES] Compatible con la serie PUMA 130.
[EN] Compatible with PUMA 130 collection.
[FR] Compatible avec la série PUMA 130.

PRIM

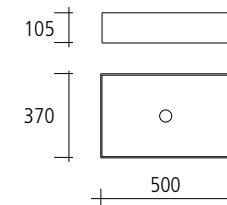

RODÓ

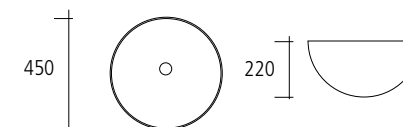

ILUMINACIÓN / ÉCLAIRAGE / LIGHTING

HARUKI
Led IP65



CALLISTO
Led IP65



NIKI
Led IP44
10 W



MAGNETIC
Led IP44
2x3,5 W



ODET XXL
Led IP44
15 W



ODET XL
Led IP44
12 W



ODET L
Led IP44
10 W



DEVA
Led IP44
5,5 W

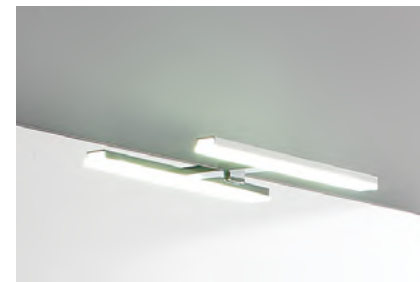

PILMA
Halógena IP44
6 W



ART
Halógena IP44
40 W



PICO
Halógena IP44
40 W



ACABADOS / FINITIONS / FINISHINGS

[ES] Acabados lacado satinado [FR] Finitions laques satinées [EN] Silk lacquered finishes

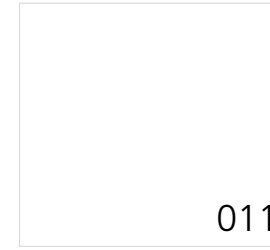

BLANCO (SATINADO)
WHITE (SILK)
BLANC (SATINÉ)



AGUAMARINA
AQUAMARINE
AIGUE-MARINE



AZUL
BLUE
BLEU



OCÉANO
OCEAN
OCÉAN



AZUL INSTA
BLUE INSTA
BLEU INSTA

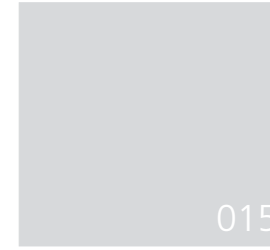

GRIS CLARO
LIGHT GREY
GRIS CLAIR



TIERRA
LAND
TERRE

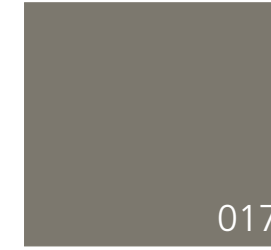

TOPO
MOLE
TAUPE

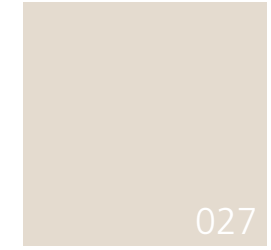

ARENA
SAND
SABLE



MARSALA

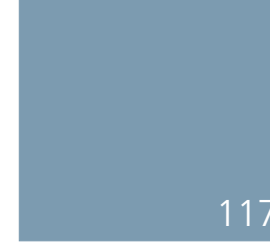

GRIS ANGORA
ANGORA GREY
GRIS ANGORA



PETRÓLEO
PETROLEUM
PÉTROLE

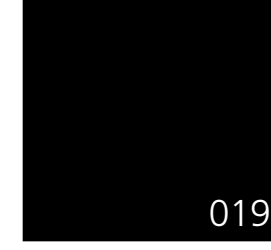

NEGRO (MATE)
BLACK (SILK)
NOIR (SATINÉ)

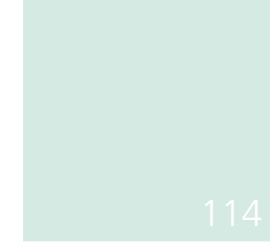

MENTA
MINT
MENTHE

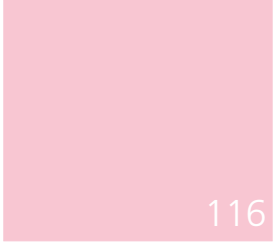

ROSA
PINK
ROSE

236 | 237

[ES] Acabados lacado brillo [FR] Finitions laques brillantes [EN] Gloss lacquered finishes

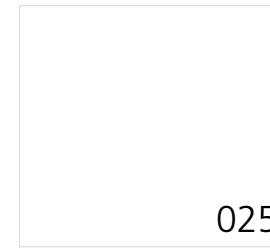

BLANCO (BRILLO)
WHITE (GLOSS)
BLANC (BRILLANT)

[ES] Acabados lacado metalizado [FR] Finitions laques métallisées [EN] Metallic lacquered finishes



BRONCE
BRONZE

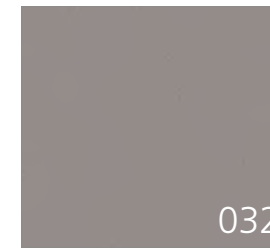

ANTRACITA
ANTHRACITE

MATERIALES NATURALES / MATIÈRES NATURELLES / NATURAL MATERIALS

[ES] Acabados texturados [FR] Finitions texturées [EN] Textured finishes

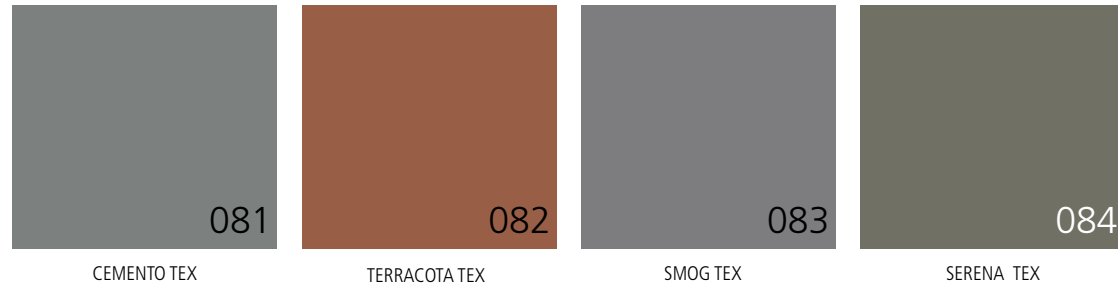

[ES] Maderas macizas [FR] Bois massif [EN] Solid Wood.

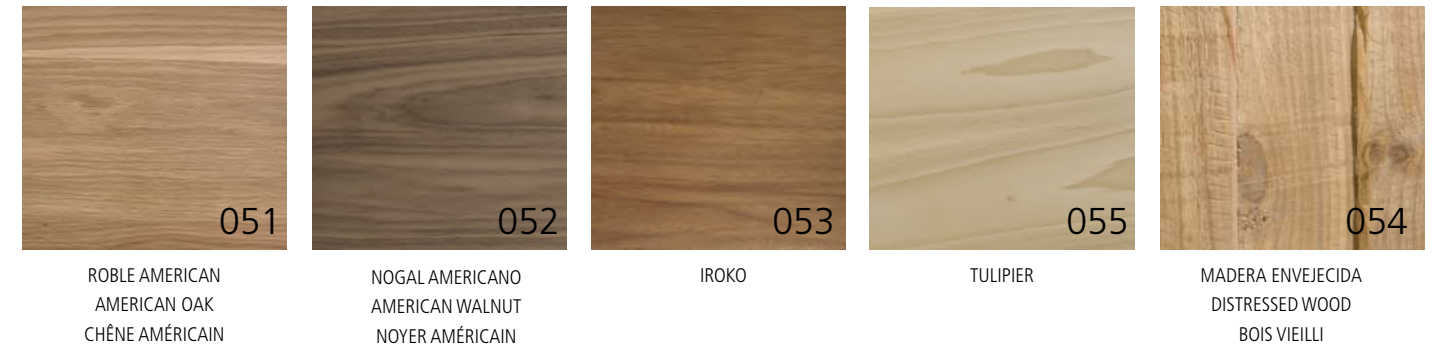

[ES] Acabados melaminados [FR] Finitions mélaminé [EN] Melaminated finishes



[ES] Rechapados [FR] Placages bois [EN] Veneer



[ES] Mármol natural [FR] Marbre naturel [EN] Natural marble

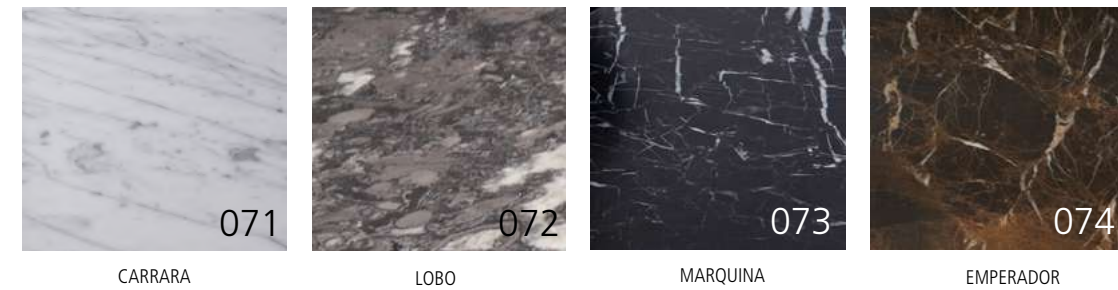

[ES] Contrachapado ó tablero marino [FR] Finitions contreplaqués marine [EN] Plywood

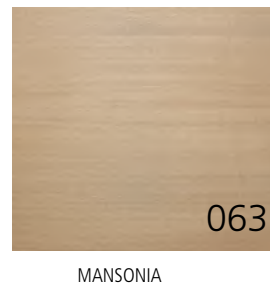

[ES] Los colores de los materiales y acabados son sólo indicativos.
 [FR] Les couleurs et finitions sont données à titre indicatif.
 [EN] Colours of materials and finishes are only indicative.

[ES] Los colores de los materiales y acabados son sólo indicativos, las maderas y piedras naturales son únicas e irrepetibles.
 [FR] Les couleurs et finitions sont données à titre indicatif. Les bois et pierres naturelles sont uniques, donc chaque pièce est différente.
 [EN] Colours of materials and finishes are only indicative. Natural stone and wood are unique and vary slightly.

[ES]

Los datos y características indicados en este catálogo no son vinculantes.
NAXANI DESIGN SL se reserva los derechos de cualquier modificación técnica y/o estética sin previo aviso.
Para especificaciones técnicas o medidas exactas les rogamos contacten con nuestro departamento comercial.
Los colores de los materiales y acabados son sólo indicativos.
Los productos del catálogo están sujetos a la Ley de Protección Jurídica del Diseño Industrial, siendo Naxani el propietario del Diseño Industrial de los mismos, registrados en la Oficina Europea de Patentes y Marcas.

[FR]

Les données et caractéristiques indiquées dans ce catalogue ne sont pas contractuelles.
NAXANI DESIGN SL se réserve le droit de tout changement technique ou esthétique sans préavis.
Pour obtenir une dimension précise ou une spécificité technique, vous devez contacter notre département commercial.
Les couleurs et finitions sont donnés à titre indicatif.
Les produits du catalogue sont la propriété de Naxani et enregistrés à l'Office de l'Union Européenne pour la propriété intellectuelle .

[EN]

The information and characteristics specified in this catalogue are not binding.
NAXANI DESIGN SL reserves the right to make any modifications without the obligation to give notice thereof.
Please contact our commercial department for technical specifications or exact measurements.
Colours of materials and finishes are only indicative.
All copyrights and intellectual property rights, including trademarks, and Industrial Design, remain the property of Naxani and are explicitly reserved on the European Union Intellectual Property Office.

NAXANI
bathroom furniture

100% MADE AND DESIGNED IN NAXANI

Naxani Design SL
Valencia, **Spain**

T. +34 962 456 363
F. +34 962 404 589
info@naxani.com

naxani.com